

DI8

Digital Input Module (8 digital inputs)

Summary

The iMAC DI8 is a input module that provides eight (8) Digital Inputs for use with Ampcontrol's iMAC system. The module is powered directly from the iMAC L1 Fieldbus communication line.

All 8 inputs may be individually configured as either normally open or normally closed contacts using 8 dip switches located behind the front fascia.

The state of all 8 inputs is communicated to the iMAC Controller via the iMAC fieldbus. The controller can initiate control logic based on the state of the DI8 inputs.

The modules address is conveniently set using the rotary dials located behind front fascia.



Data Register(s)

1 (Input)

Features

- 8 voltage free contact inputs (configurable N/O or N/C)
- Down-line powered from the iMAC L1 Fieldbus
- Rotary switch configuration
- Individual input indication LEDs
- Multifunction diagnostic status LED
- Remotely monitored via the iMAC Controller
- Standard DIN rail or foot mounting

Minimum System

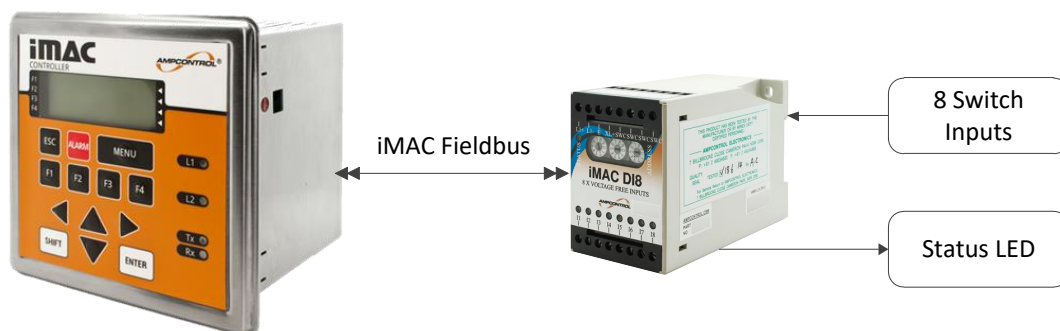

CAUTION!



The DI8 must NOT be installed in a hazardous area – module is NOT intrinsically safe.

Electrical Connections

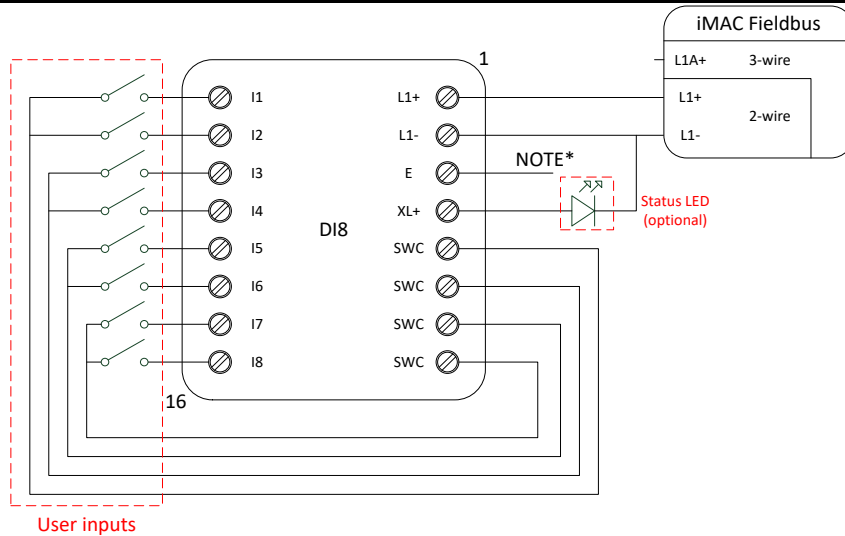

Maximum lead length between switch inputs and the voltage free contacts is NOT to exceed 10m.
If a single pair individually screened cable is used for each input, this distance can be extended to 30m.
Note: refer to iMACB094 – iMAC Installation Requirements

Terminal	Label	Type	Description
1	L1+	L1 Comms	iMAC Fieldbus (2 wire)
2	L1-		
3	E		Earth point for internal lightning protection (with respect to L1-)
4	XL+	LED Output	Status (connect the cathode to L1-)
5	SWC	Switch Inputs	Common (pulsed voltage source)
6	SWC		
7	SWC		
8	SWC		
9	I1		User (8)
10	I2		
11	I3		
12	I4		
13	I5		
14	I6		
15	I7		
16	I8		

Data Register(s)

Digital Input Register				
Bit	Description	Bit Value	R / W	Invert Bit
15	-	X	r	-
14	-	X	r	-
13	-	X	r	-
12	-	X	r	-
11	-	X	r	-
10	-	X	r	-
9	-	X	r	-
8	-	X	r	-
7	Input 8 (I8)	0 / 1	r	7 (0080h)
6	Input 7 (I7)	0 / 1	r	6 (0040h)
5	Input 6 (I6)	0 / 1	r	5 (0020h)
4	Input 5 (I5)	0 / 1	r	4 (0010h)
3	Input 4 (I4)	0 / 1	r	3 (0008h)
2	Input 3 (I3)	0 / 1	r	2 (0004h)
1	Input 2 (I2)	0 / 1	r	1 (0002h)
0	Input 1 (I1)	0 / 1	r	0 (0001h)

Configuration Parameters

(Refer to document IMACB005 - iMAC module parameters programming procedure)

The Rotary Address version of the iMAC DI8 Module has no programmable parameters; however, the module will still respond to roll-call commands so that its configuration can be checked remotely.

Input Register Parameters (roll-call name: DI8 Module)					
No	Description	Range	Default	Units	R/W
1	Input register address	1 - 255	0	-	r (Set via 3 rotary switches*)
2	Input register Ix bits invert	0000h - 0080h	0000h	-	r (Set via 8 way DIP switch*)
3	Not used (Factory use)	-	-	-	r
4	Not used (Factory use)	-	-	-	r

*Remove front cover from enclosure to access.

Parameter Details...

Parameter 1: Input register address – set via the three rotary dials behind the modules front cover. Addresses greater than 255 will be clipped to 255. An address of 0 will put the module offline. This can be useful for fault finding.

Input Register Address	
Rotary switch	Input register address modifier
1 (left)	100's
2 (middle)	10's
3 (right)	1's





Parameter 2: Invert bits – set via the 8 DIP switches located behind the modules front cover. The invert bits specify whether received digital input state sets the output data bit to 0 or 1. If invert bit is 0 (factory default – DIP switch off), then corresponding digital input register is set when the input switch is open. Alternatively, if invert bit is 1 (DIP switch on), then corresponding digital input register is set when the input switch is closed.

Input Bits Ix (x = 1 to 8) Truth Table			
Input switch	DIP Switch x	Input register parameter - invert bit value	Input register - Ix bit value
Open	OFF	0 (N/C)	1
Closed	OFF	0 (N/C)	0
Open	ON	1 (N/O)	0
Closed	ON	1 (N/O)	1

Functional Logic

The inputs are scanned every 200ms and the DI8 initiates an “exception scan” when the input data changes. This facilitates a fast response to data changes. Only one exception scan is allowed per “round robin” scan. This guarantees a background scanning rate.

LED Indicators

Status LED (RED)			
	Sequence	Module – iMAC Comms Status	Module – Function Status
Off		Unknown (check connections)	Unknown (check connections)
Slow Flash		Healthy	All input register Ix bits = 0
2 Flashes		Healthy (has been roll-called)	-
3 Flashes		Error (address clash)	-
Fast Flash		Warn (general)	Any input register Ix bit = 1

Input LEDs I1 to I8	
Off	The associated input (Ix) is (physically) open
Flash (5 Hz)	The associated input (Ix) is (physically) closed - connected to SWC

Specifications	
Mechanical	
Dimensions	110 mm (Height) x 55mm (Width) x 75mm (Depth)
Weight	230g
IP Rating	IP20
Mounting	Standard 35mm DIN rail (Top Hat Rail – EN50022)
Electrical Connections	ERNI screw terminals (maximum wire size of 4mm ² , maximum torque of 0.4 Nm)
Environmental	
Operating Temperature	0°C to +50°C
Digital Inputs (8 self-wetting)	
Limits	14VDC (pulsed) @ <4.7mA
Outputs	
Status LED	Internally current limited 2.4VDC source – external resistor not required
Limits	LED forward voltage < 2VDC
Communications (iMAC L1)	
Hardware interface	2 wire (+/-18VDC or +/-21VDC iMAC Fieldbus)
Line Speed	300 - 1000 baud
Bit protocol	iMAC proprietary
L1 Isolation	None
L1 Line Loading (baud)	0.42mA (300) / 0.62mA (500) / 1.44mA (1000)
Find Out More	
For more information on this product, contact Ampcontrol Customer Service on +61 1300 267 373 or customerservice@ampcontrolgroup.com or visit the Ampcontrol website: www.ampcontrolgroup.com	

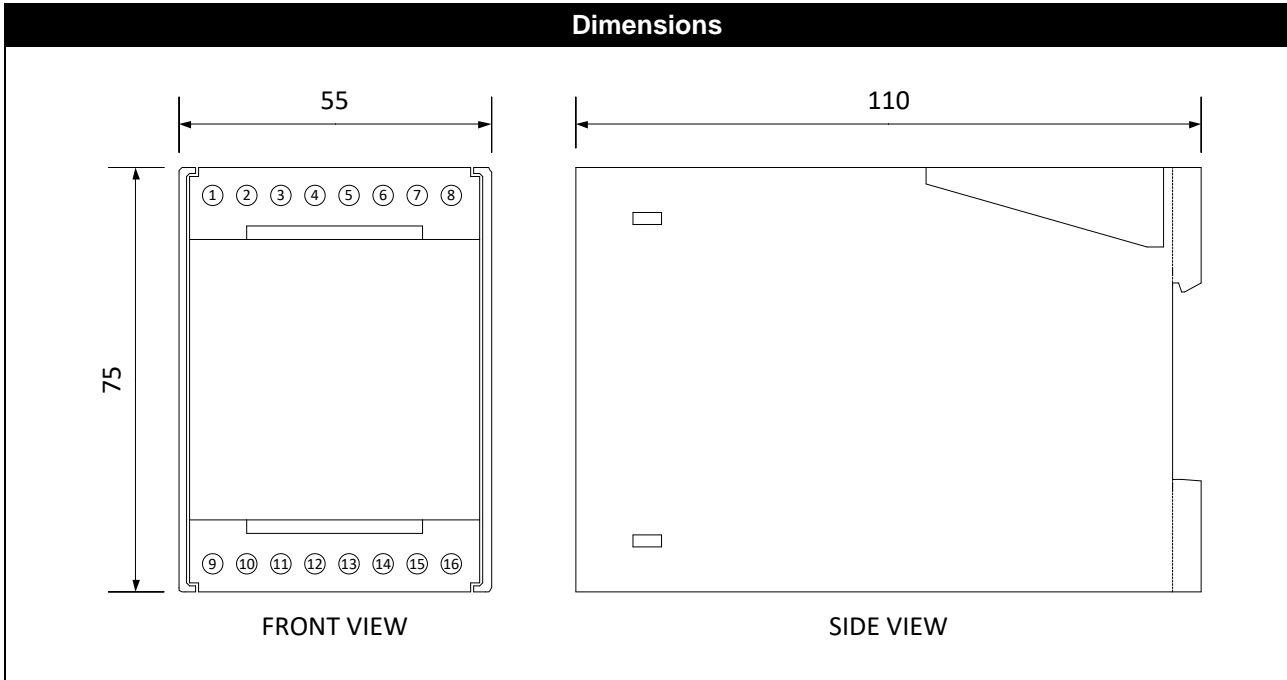

Equipment List	
Part Number	Description
101495	MODULE IMAC DI8
120942	MODULE IMAC DI8 PLUG TYPE (2 x 8-way phoenix plugs)

DISCLAIMER

While every effort has been made to ensure the accuracy of this document at the date of issue, Ampcontrol assumes no liability resulting from any omissions or errors in this document, and reserves the right to revise content at any time.